

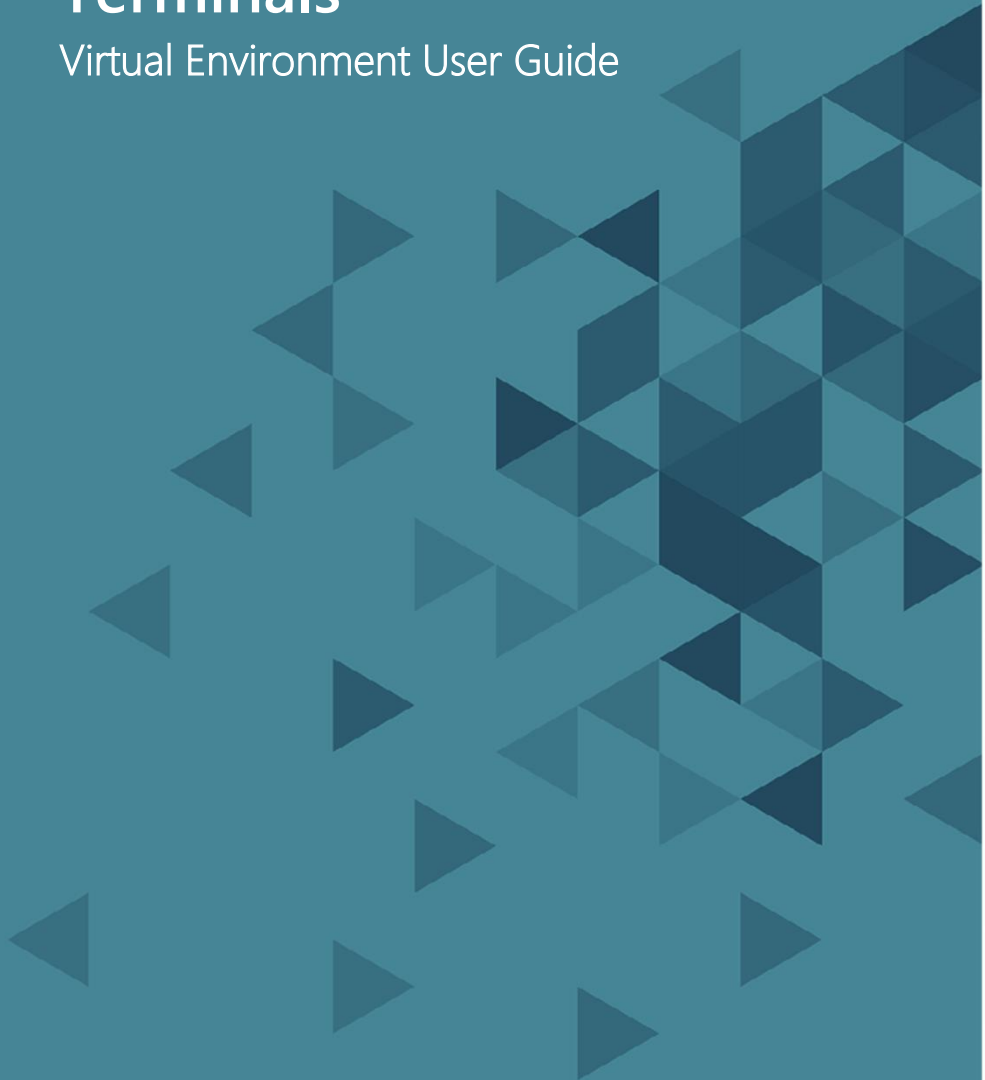

INTEGRATED
ENVIRONMENTAL
SOLUTIONS

Passivent Roof Ventilation Terminals

Virtual Environment User Guide



Contents

1. Overview	2
What are Passivent Roof Ventilation Terminals?.....	2
Requirements for using Passivent Roof Ventilation Terminals in the Virtual Environment	6
2. Performance requirements	7
3. Using Passivent Roof Ventilation Terminals in the VE	9
Introduction	9
Preparing the model for BB101 analysis.....	10
Importing Roof Ventilation Terminals	12
Editing component parameters.....	13
Inserting a Passivent Roof Ventilation Terminal (without low level inlets) into a room.....	15
Inserting a Passivent Roof Ventilation Terminal (with low level inlets) into a Room	20
Simulation with Passivent Roof Terminals	22
4. Results analysis	23
5. Comfort analysis (design)	26
6. Comfort analysis (compliance)	27
7. UK NCM analysis (Part L & EPCs)	29
The NCM framework	29
Analysing the Real Building and the Actual Building	29

1. Overview

What are Passivent Roof Ventilation Terminals?

Passivent Roof Terminals are a range of roof mounted ventilation products comprising:

- Airscoop®.
- Airstract®.
- Airstract® iAT.
- Hybrid Plus Airstract®.
- Litevent Airstract

Passivent Airscoop® (with or without low level inlets) is a range of roof mounted natural ventilation terminals which provide displacement (or top down) ventilation using wind power only. Suitable for buildings with large open areas, deep plan spaces and open plan top floors.

In addition to the Passivent Airscoop, using low level motorised louvres (such as the Passivent Aircool façade ventilators) or manual opening windows/doors can provide assistance to the system during low wind speed periods.

Designed to 'capture' prevailing wind and direct it via four separate chambers within the terminal to the space beneath. The optimised segmented design delivers maximum airflow capacity with minimal pressure drop through the system and the complete separation of chambers prevents 'short circuiting'.

System to comprise: ABS Airscoop terminal with internal dividers is fitted to an Airscoop base unit. The base unit is extended into the building to house the insulated base motorized controllable damper unit. All necessary flashings, secret gutters etc to be provided and installed by others.

Passivent Airscoops are covered by a 15 Year No Leak Guarantee. No annual servicing is required for this guarantee as there are no mechanical/electrical items such as actuators, within the terminal to maintain, therefore no external/roof access is required.

For more information, visit <https://www.passivent.com/products/roof-ventilation-terminals/>.

Product Data Sheet:

https://www.passivent.com/app/uploads/2022/01/PVCT15-Airscoop-Specification-Document_Issue-3_Aug-2024_F-A.pdf

Passivent's Airstract® (with low level inlets) roof-mounted natural ventilation terminal combines low airflow resistance with high airflow capacity providing an exhaust outlet for used air. The natural forces of buoyancy, wind and convection move the air and minimal power is required.

Used for passive stack ventilation applications in conjunction with low level motorised louvres (such as the Passivent Aircool façade ventilators), they can ventilate deep plan spaces and provide night cooling. They can also be used for multiple extract applications and mechanical extract outlets.

System to comprise: ABS Airstract terminal is fitted to an Airstract base unit. The base unit is extended into the building to house the insulated base motorized controllable damper unit. All necessary flashings, secret gutters etc to be provided and installed by others.

Passivent Airsttracts are covered by a 15 Year No Leak Guarantee. No annual servicing is required for this guarantee as there are no mechanical/electrical items such as actuators, within the terminal to maintain, therefore no external/roof access is required.

For more information, visit <https://www.passivent.com/products/roof-ventilation-terminals/>.

Product Data Sheet:

<https://www.passivent.com/app/uploads/2022/01/PVCTI3-Airstract-Specification-Document-Issue-2-August-24.pdf>

Passivent Airstract® iAT (intelligent Airflow Technology) (with low level inlets) roof mounted ventilation terminal has all the features and benefits of the standard Airstract terminal in addition to energy efficient mechanical assistance.

Used for passive stack ventilation applications in conjunction with low level motorised louvres (such as the Passivent Aircool façade ventilators), they can ventilate deep plan spaces and provide night cooling. They can also be used for multiple extract applications.

During peak summer temperatures the minimal temperature difference between indoors and outdoors can result in low flow rates for passive stack ventilation, especially on still, windless days. The control system activates the low energy fan and maintains the ventilation system performance until either the temperature or CO2 levels have achieved the targeted set point.

System to comprise: ABS Airstract iAT terminal is fitted to an Airstract iAT base unit. The base unit is extended into the building to house the low powered sweep fan and insulated base motorised controllable damper unit. All necessary flashings, secret gutters etc to be provided and installed by others.

For more information, visit <https://www.passivent.com/products/roof-ventilation-terminals/>.

Product Data Sheet:

<https://www.passivent.com/app/uploads/2022/01/PVCTI3-Airstract-Specification-Document-Issue-2-August-24.pdf>

Passivent Hybrid Plus Airstract® (with low level inlets) roof-mounted terminal has all the features and benefits of the standard Airstract terminal as well as an innovative air tempering and mixing unit utilising a single low power sweep fan.

Used for a range of ventilation applications, particularly on upper floors of buildings where direct perimeter ventilation is limited or undesirable. Also suitable for large open buildings such as sports halls and auditoriums.

A number of different modes can be programmed to allow the most energy efficient option to be used as and when required.

1. In natural or passive mode when the fan does not operate it acts as a passive stack
2. In peak summer temperatures to avoid overheating, enhanced (or boost) mode allows for high levels of air movement. Based primarily on natural ventilation strategy so does not require large and costly mechanical plant. It can also purge the space more rapidly at times of unusual high building occupancy when there are excessive CO2 levels or heat gains.
3. In low winter temperatures to avoid draughts, the recirculation (or mixing) mode mixes incoming fresh air with interior warm air to provide tempered fresh air to the space.

System to comprise: ABS Hybrid Plus Airstract terminal is fitted to an Hybrid Plus Airstract base unit. The base unit is extended into the building to house the mixing chamber, low powered sweep fan and insulated base motorised controllable damper unit. All necessary flashings, secret gutters etc to be provided and installed by others.

Passivent Airsttracts are covered by a 15 Year No Leak Guarantee. No annual servicing is required for this guarantee as there are no mechanical/electrical items such as actuators, within the terminal to maintain, therefore no external/roof access is required.

For more information, visit <https://www.passivent.com/products/roof-ventilation-terminals/>.

Product Data Sheet:

<https://www.passivent.com/app/uploads/2022/01/PVCTI26-Hybrid-Plus-Airstract-Issue-2-August-2024.pdf>

Passivent Litevent Airstract® Rooflight/Ventilator (with low level inlets) combines a controllable ventilator and a rooflight in one unit for installation on flat or low-pitched roofs. The added natural daylighting reduces the need for artificial lighting, thereby further reducing energy expenditure.

Used for passive stack ventilation applications in conjunction with low level motorised louvres (such as the Passivent Aircool façade ventilators), they can ventilate deep plan spaces and provide night cooling. They can also be used for multiple extract applications.

System to comprise: Aluminium upstand with insulated core, incorporating insulated ventilation doors on all four sides, controlled by modulating linked actuators. The glazing is a triple-skin polycarbonate glazing with vented air gap. All necessary flashings, secret gutters etc to be provided and installed by others.

For more information, visit <https://www.passivent.com/products/roof-ventilation-terminals/>.

Product Data Sheet:

https://www.passivent.com/app/uploads/2022/01/PVCTI18_Litevent-Specification-Documents_Issue-1_May-18.pdf

All Passivent Roof Terminals can provide secure night-time cooling and where provided have exceptionally low specific fan powers.

All Passivent Roof Terminals can be controlled by a range of Passivent controls including the intelligent and fully automatic iC8000 control system. This modulates the opening of the roof terminals depending on the season, external/internal temperature conditions and indoor air quality (IAQ) to ensure the lowest possible energy use - in terms of both the energy consumption of the ventilation system and overall building energy usage.

Requirements for using Passivent Roof Ventilation Terminals in the Virtual Environment

The Virtual Environment (VE) software includes built-in support for simulating Passivent Roof Terminal units in the form of components and a Navigator.

The VE supports Airscoop® Roof Terminal units (with or without low-level inlets) and Passivent's Airstract®, Passivent Airstract® iAT, Passivent Hybrid Plus Airstract®, Passivent Litevent Airstract® units (all with low-level inlets).

In order to simulate you will need valid licenses for the following VE modules:

- ModeliT.
- Apache.
- MacroFlo.
- SunCast.
- Radiance (for Litevent only).
- ApacheSim.

Passivent Airstract® iAT and Passivent Hybrid Plus Airstract® product involve the use of ApHVAC networks, however a licence is not required for simulation.

If you are missing one or more of these licenses, you will not be able to use the Passivent Roof Terminals functionality within the VE. Please contact keys@iesve.com for queries or support with licensing issues.

To formally assess overheating you also need an appropriate weather file, however no check is made to enforce the correct choice of weather file for the overheating analysis

2. Performance requirements

For buildings other than schools it is likely CIBSE TM52:2013, ISO 7730: 2005 or ASHRAE 55: 2013 will be utilised to assess comfort performance.

For schools in the UK & Eire BB101:2018 is the definitive guidance on performance. The performance standards in BB101:2018 require:

- Thermal comfort performance checks:

For buildings operating in a *free running* mode adaptive comfort is specified using CIBSE TM 52 (BB101:2018 7.6). This involves three criteria, taken together, to be used to assess the risk of overheating of the building in the UK, using the geographically closest CIBSE Design Summer Year (DSY1 2020 50th percentile) weather file. A room or building that fails any two of the three criteria is classed as overheating:

- Criteria 1- Hours of Exceedance: During the occupied hours of the non-heating season (1st May to 30th September), the predicted operative temperature should not exceed the maximum adaptive temperature by 1°K or more, for less than 40 hours;
- Criteria 2- Daily Weighted Exceedance: For the severity of overheating, which can be as important as its frequency, the weighted exceedance of the temperature rise and its duration should be less than or equal to 6 during any occupied day of the non-heating season;
- Criteria 3- Upper Limit Temperature: The absolute maximum daily operative temperature for a room, beyond which the level of overheating is unacceptable, should not be greater than or equal to 4°K, than the maximum adaptive temperature (Top – Tmax), at any time.

For buildings operating in a *mechanically cooled* mode PMV is specified as CIBSE Guide A (BB101:2018 3). This references ISO 7730 and PMV thresholds of:

- Category I (A) +0.2 (<6% PPD).
 - Category II (B)+0.5 (<10% PPD) (Normal).
 - Category III (C) +0.7 (<15% PPD).
- Air quality performance checks:

With regards to internal air quality, BB101:2018 (2.4) criteria specifies that for *natural ventilation or hybrid* systems operating in *natural* mode:

- In all teaching and learning spaces when measured at seated head height, during the continuous period between the start and finish of teaching on any day, the average CO2 concentration of carbon dioxide should not exceed 1500 parts per million (ppm).
- The maximum CO2 concentration should not exceed 2000 parts per million (ppm) for more than 20 minutes each day.

- The system should be designed to achieve a CO₂ level for the majority of the time of less than: 1200 ppm for a new building (800 ppm above the outside CO₂ level, taken as 400ppm) and 1750ppm for a refurbished building (1350ppm above CO₂ level).

For systems operating in *mechanical ventilation or hybrid mechanical* mode, BB101:2018 (2.4) criteria specifies that:

- In all teaching and learning spaces when measured at seated head height, during the continuous period between the start and finish of teaching on any day, the average CO₂ concentration of carbon dioxide should not exceed 1000 ppm;
- The maximum CO₂ concentration should not exceed 1500 parts per million (ppm) for more than 20 minutes each day.

BB101:2018 1.2.3 and figure 1-2 describe system types and operating modes.

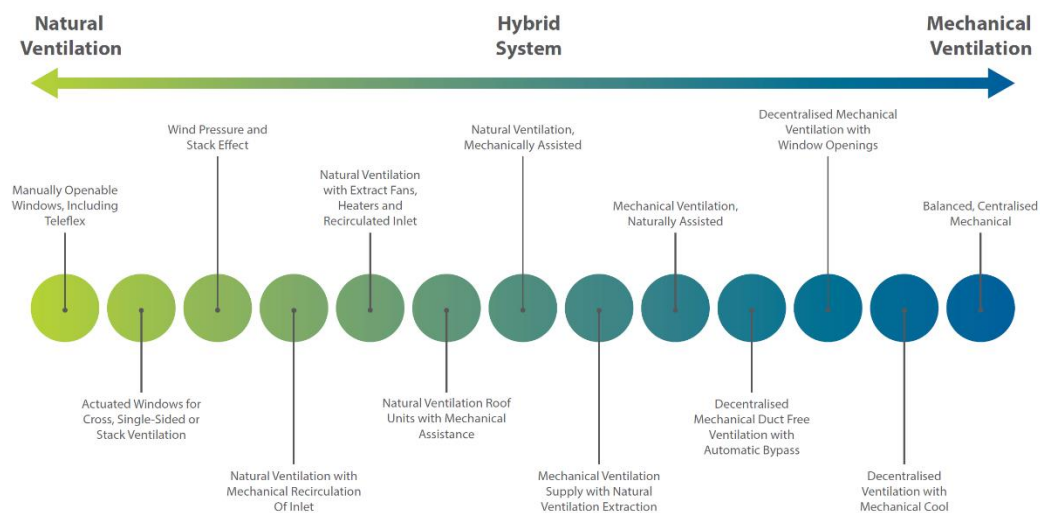

Fig 1: BB101:2018 figure 1-2

The VE provides tools for assessing performance requirements for all these standards via the VistaPro Comfort Analysis tool. Both natural and mechanical modes are assessable.

3. Using Passivent Roof Ventilation Terminals in the VE

Introduction

The integration of Passivent Roof Terminals into the VE provides a fast, streamlined and easy-to-use method of simulating the effect of Passivent Roof Terminals within your VE building model.

A dedicated Navigator is used to guide you through the step-by-step process, from importing the products into your model, configuring their operation, preparing, and applying to rooms, thermal simulation and compliance analysis.

To get started, click on the dropdown list of available Navigators at the top of the *Navigators* pane (if the pane is not visible on the left side of the VE window, you can turn it on using the  button on the application toolbar, or by selecting Navigator from the view menu). You will find a Passivent Roof Terminals® entry listed under the *Partners* section.

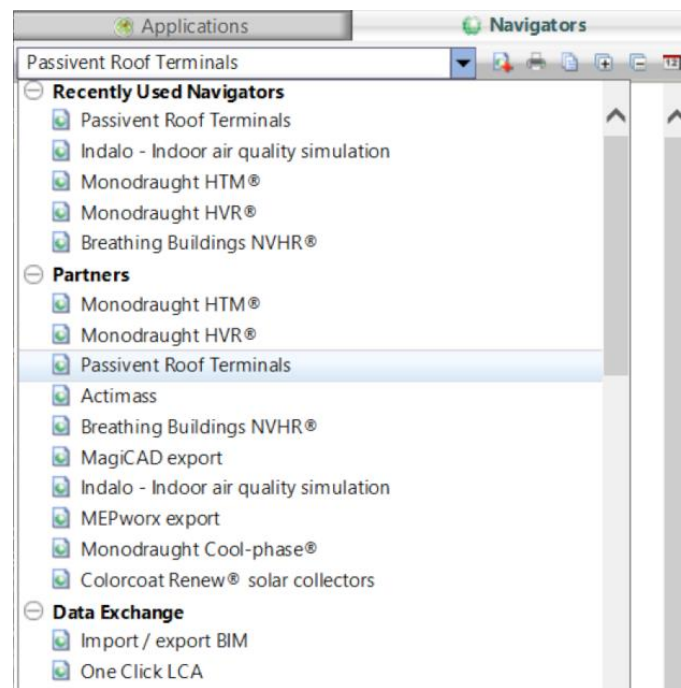

Fig 2: VE Navigator list

When selected, the *Passivent Roof Terminals* Navigator will be displayed. This is what you will use to go through the process of applying Passivent Roof Terminals to your building, simulation, and analysing the results.

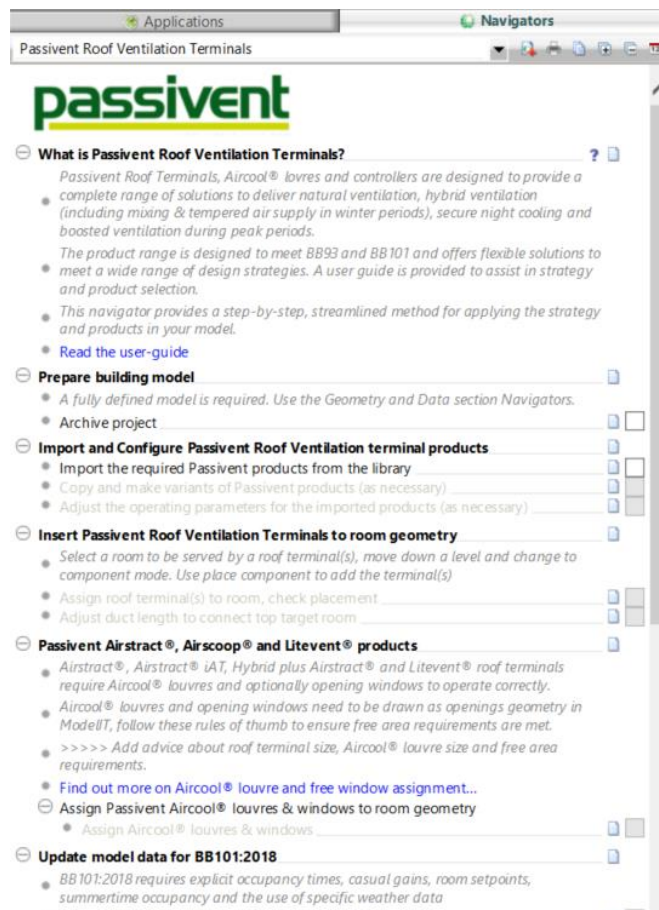

Fig 3: Passivent Roof Terminals Navigator

In order to start using the Navigator, you will need to have a fully defined VE model already created and loaded. This model should contain valid geometry representing the building, and also be set up with valid data (e.g. heating set-points, cooling set-points, Apache systems, internal gains, air exchanges, MacroFlo openings) already assigned to the rooms.

As the assignment of Passivent Roof Terminals to rooms will make direct modifications to the assigned data, it is always recommended that you **make a back-up of your model prior to commencing the integration** – this will allow you to have a baseline that you can easily revert to in the event of any issues. You can do this by clicking the *Make an archive of the current model before making changes* item in the navigator, or by selecting the *Current Project* option from the *File->Archive* menu.

Once completed, you will be ready to start using Passivent Roof Terminals in your building model.

Preparing the model for BB101 analysis

In order to carry out a BB101:2018 performance analysis the model and data on target rooms need to be set-up in accordance with the requirements of standard.

This involves assigning an appropriate weather file (not enforced), the background CO₂ level (not enforced) plus importing and assigning prototype data to target rooms. The Navigator leads you through this process. If you are using Airscoop® mixed-mode (mechanical cooling) you will also need to setup the cooling system manually.

Importing prototype data adds room template data: profiles, gains and infiltration to the model. All are appropriately labelled.

The creation of a Passivent Roof Terminals room group allows target rooms to be identified and the imported data changes to be applied to the target rooms quickly.

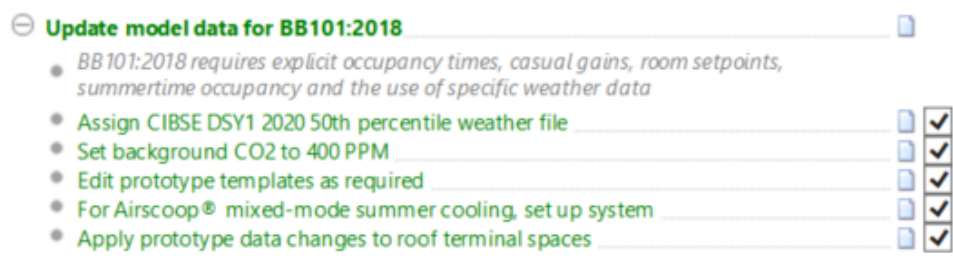

Fig 4: – Navigator BB101 data assignment

The changes applied to the target rooms are as follows:

- Apsys methodology (or ApHVAC for Airsttract iAT, Hybrid Plus Airsttract).
- Room heating operation.
- Room heating set-point variation profile.
- Room cooling profile set to cooling operation.
- Room occupancy profile.
- Room lighting profile.
- Room small power profile.

For template gains:

- Occupancy gains 32 people 70/50W.
- Lighting gains 7.2 W/m².
- Small power gains 10 W/m².

The target ApHVAC networks (for Airsttract iAT, Hybrid Plus Airsttract) will include assignments for:

- Ventilation flows.
- Room heating operation.
- Room heating set-point variation profile.
- Room cooling profile.

Users can subsequently edit the gains as required within the limits of BB101:2018 if required.

Other changes made:

- Infiltration 0.25 ACH continuously ON.
- System o/a supply variation profile turned off.
- Existing auxiliary ventilation air exchanges variation profile turned off.
- Existing natural ventilation air exchange variation profile turned off.
- Comfort settings will be set to nominal air speed 0.1m/s, elevated air speed 0.3 m/s, MET 1.2, CLO MOD profile min 0.5 max 1.0.

Importing Roof Ventilation Terminals

To get started with Passivent Roof Terminals, you will need to import the required unit(s) into your building model.

Multiple Roof Terminal types can be imported into a project, however, note that only one type can be used in a single room. Multiple instances of the same type (up to six) can be inserted in a single room.

The units are represented in the VE by *components* – when placed into a room, the room will automatically be updated to make use of the Passivent Roof Terminals unit and associated data. You can import the units by clicking on the *Import the Passivent products from library* item in the Navigator – this will open the *Add Components From Library* window with the *Passivent Roof Terminals*:

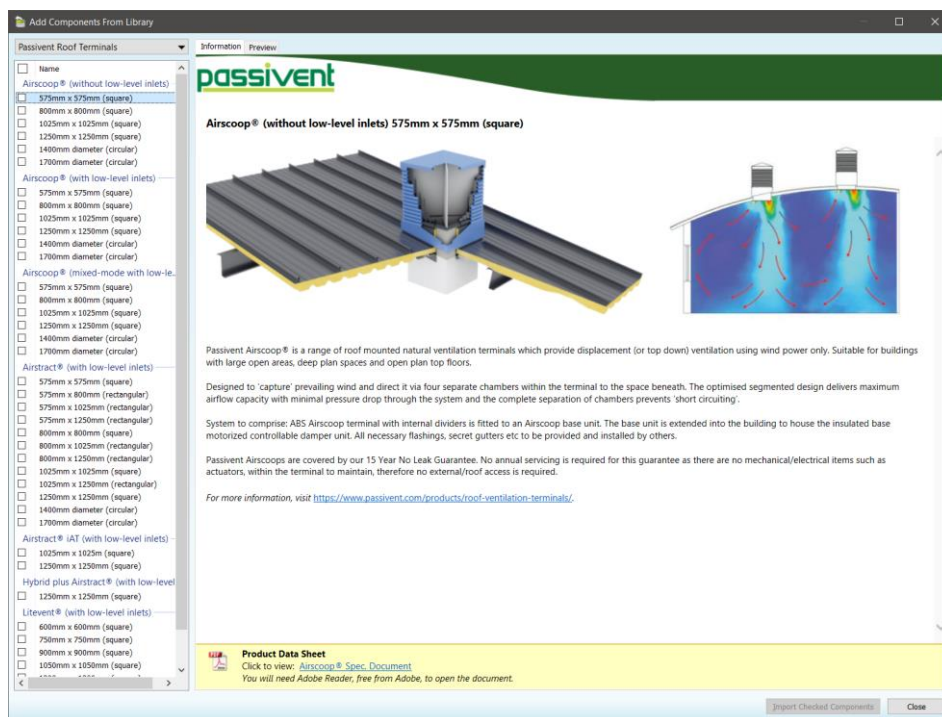

Fig 5: Component library

The Passivent Roof Terminals includes sections for the different Roof Terminal products; note the difference between products without low-level inlets and with low-level inlets.

- Products **without** low-level inlets are standalone roof terminals.
- Products **with** low-level inlets are roof terminals which work in conjunction with associated room wall louvres and windows that are drawn by the user.

For the roof terminal products there are five types that you can import into the VE; in each type there is a choice of size and shape:

- Airscoop®.
- Airstract®.
- Airstract iAT®.

- Hybrid Plus Airsttract®.
- Litevent® Airsttract.

Details on selecting which type of unit is best suited for your project should be discussed with Passivent. You can review the overview of each unit by clicking on it – this will also lead to the Passivent specification document.

To import the units, click on the checkbox next to the type(s) you want, then click on the *Import Checked Components* button. This will then copy the relevant component(s) into your model’s component library, making them ready to be assigned to rooms.

In addition to the unit(s) themselves, the import of a Passivent Roof Terminals unit to the model will also import some data into the project:

- Apache room templates for Passivent Roof Terminals ‘spaces’.
- Apache constructions for Passivent Roof Terminals surfaces.
- Macroflo types for Passivent Roof Terminals louvres.
- Apache profiles for Passivent Roof Terminals louvres and dampers (doors).
- ApHVAC network files for Passivent Airsttract® iAT and Passivent Hybrid Plus Airsttract® types.
- MacroFlo opening types for louvres and windows for assignment to room louvres and windows.

Once the units have been imported, you can close the *Add Components from Library* window by clicking on the *Close* button.

Editing component parameters

Once you have imported roof terminal components from the library, and before insertion into the model, component details can be viewed and edited to set design setpoints etc.

In the Navigator select *Copy and make variants of Passivent products* or open *Component modeller*.

Using the Component library object browser, you will see a list of component categories; under the Passivent category there will be a list of all the imported Passivent Roof Terminal components.

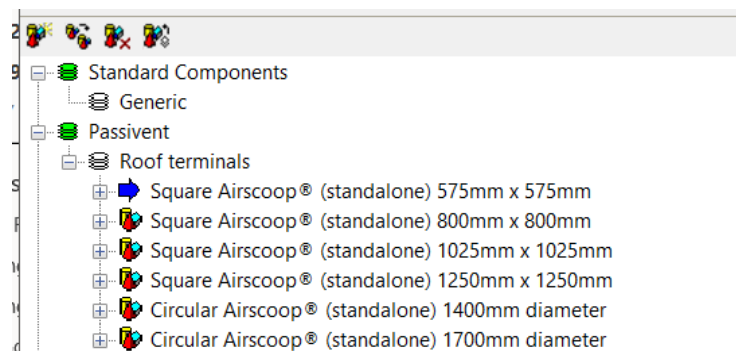

Fig 6: Component modeller browser

Right-click on one of the Passivent components and select the *Properties* option:

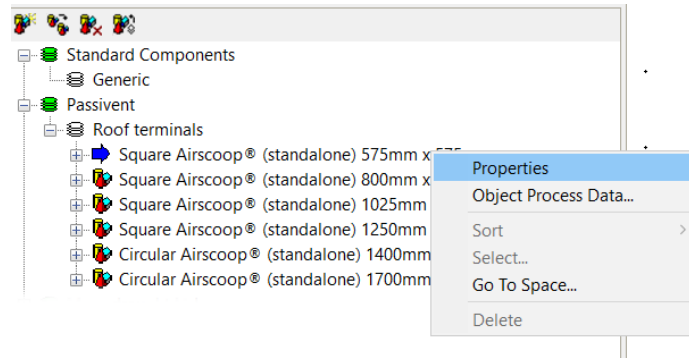

Fig 7: Component modeller browser menu

This will display the *Component Properties* window, consisting of two tabs: *Properties* and *Information*.

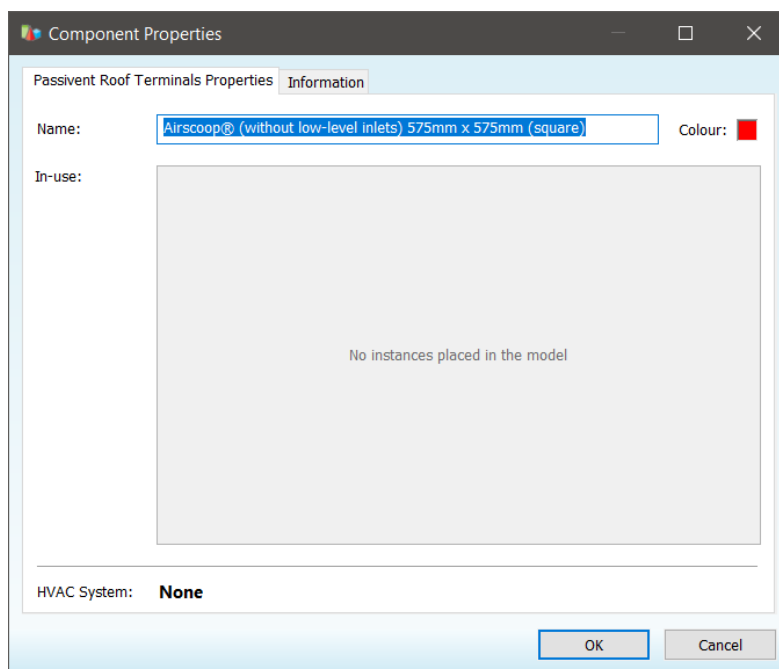

Fig 8: Component properties dialog (without low level inlets)

The *Properties* tab (without low level inlets) allows you to edit the component name and see if the component is in use in the model.

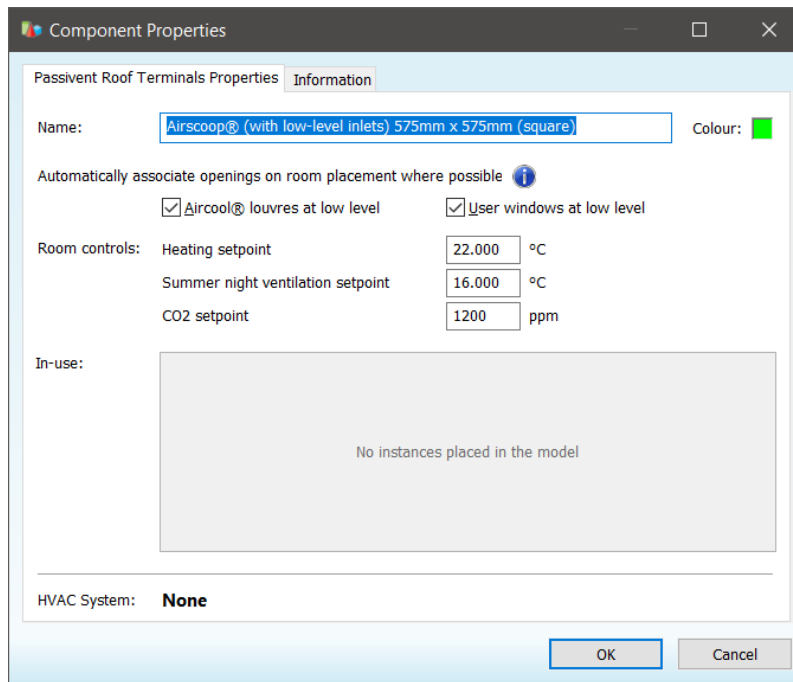

Fig 9: Component properties dialog (with low level inlets)

The *Properties* tab allows you to edit the component name, where possible louvres and windows should be automatically identified when applied to a room, edit terminal controls operational setpoint and to see if the component is in use in the model.

Within Component modeller components can be created, copied and deleted using the icons on the browser.



Fig 9: Component actions

Inserting a Passivent Roof Ventilation Terminal (without low level inlets) into a room

With the appropriate components imported to the project and component properties set (see previous section for details), the components are ready to be assigned to room(s) in your model.

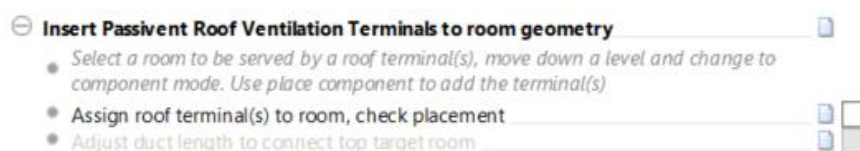
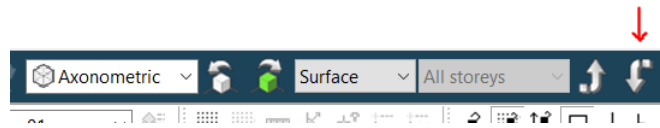

Fig 10: Inserting a component navigator

The *Passivent Roof Terminals* Navigator guides you through the process:

1. Make sure you are in ModeliT.

2. Select the target room in the view.
3. Use the down arrow to move down one level.



4. Change display mode to *component*.

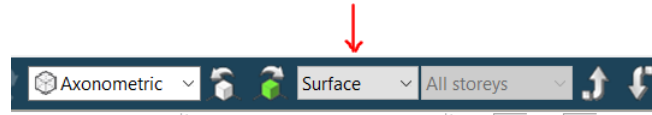

5. The place component dialog will be displayed.

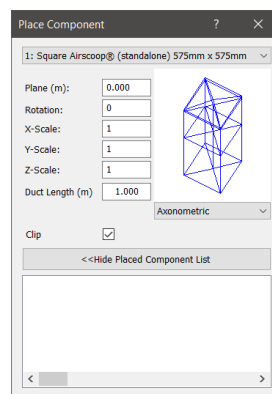

6. Use the combo-box to select the required component.
7. Revise the *plane & duct length* parameters to suit the target placement.
8. Make sure the view is in a 2D view mode e.g. *plan* mode.

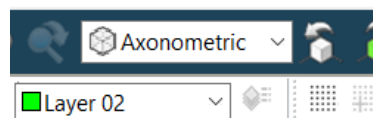

9. The component will now appear at the cursor and can be placed in the selected plane; left click fix the position.

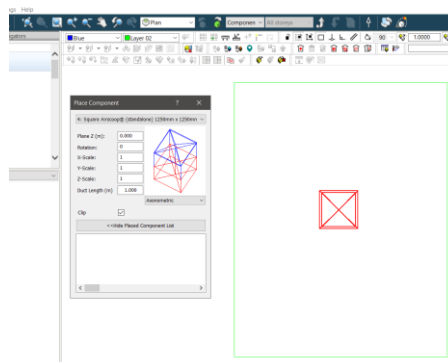

10. A message may appear; *The component is NOT ABOVE*. This means that the component is not positioned correctly vertically (as we have only located it in the plan view); press OK and close the dialog.
11. Change the view mode to *front* or *right* or *left* view. We can see the component is at room floor level so we need to move it upwards.

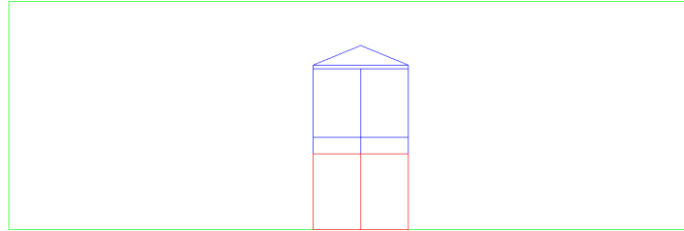

12. Pick the whole component by using drag select.

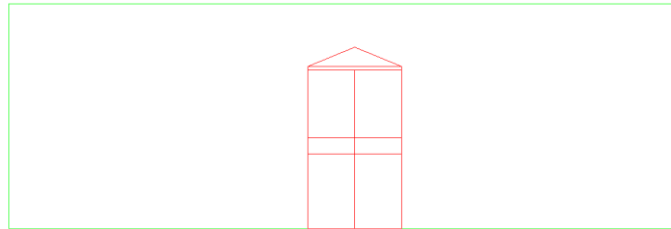

13. Make sure locks are set appropriately (model end point, grid lock etc.)
14. Click on the *Move selection set* tool.

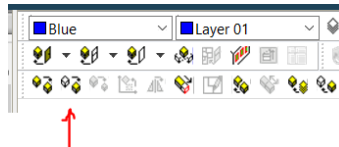

15. Pick a point on the selection set and select-drag the terminal to the room ceiling so that the bottom of the terminal **just overlaps** into the room.

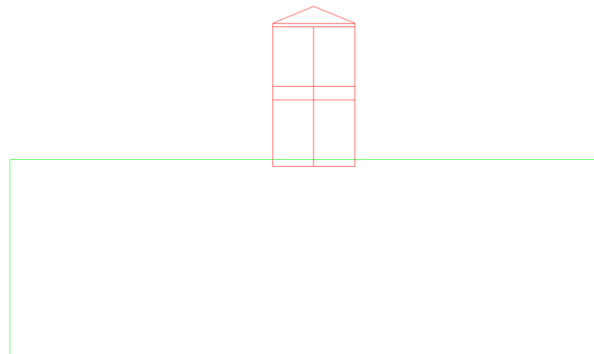

Ensure that the upper part of the roof terminal (shown in green) does not overlap with any objects or the finalisation process will not work correctly.

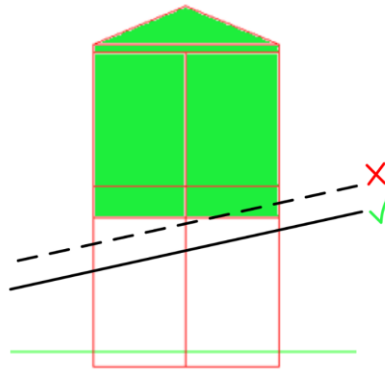

16. In the views check you are satisfied with the terminal position in all planes.
17. At this point the component is not yet finalized / cut in to the model geometry. Repeat the placement process on other rooms as required.
18. Follow the Navigator section 'Update model data for BB101:2018'.
19. Follow the Navigator section 'Validate Roof terminal assignments' firstly checking that all assignments are correct – clicking on this Navigator entry will run checks and display a message box. In the viewport a warning icon is also displayed on rooms where assignments are incorrect, hovering on the icon will display the issue.

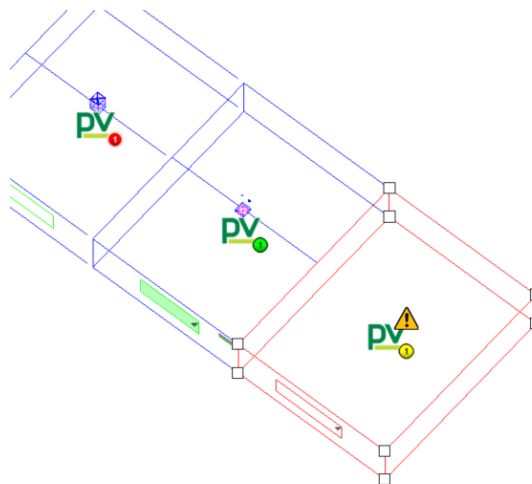

20. Once validated press 'Finalise roof terminal(s)'. The VE now cuts or fixes the component into the model geometry and applies data changes to the room. You will notice that target surfaces and any surfaces in spaces through which the component passes are split in two; this ensures 'island' surfaces are not created.
21. Move back up one level.

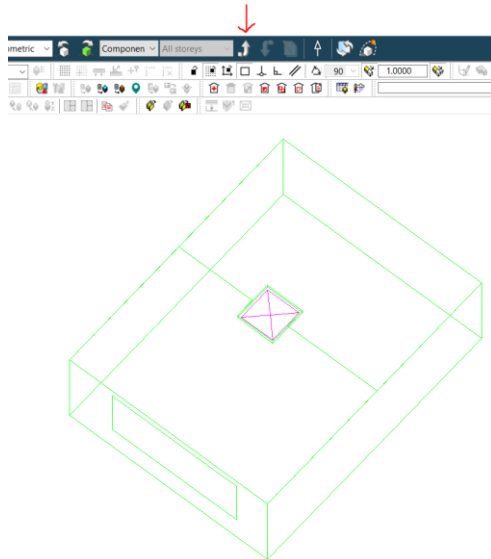

22. The component is now inserted into the model. In this example it is cut through the roof void space above the room. This example demonstrates the need to adjust the duct length parameter.

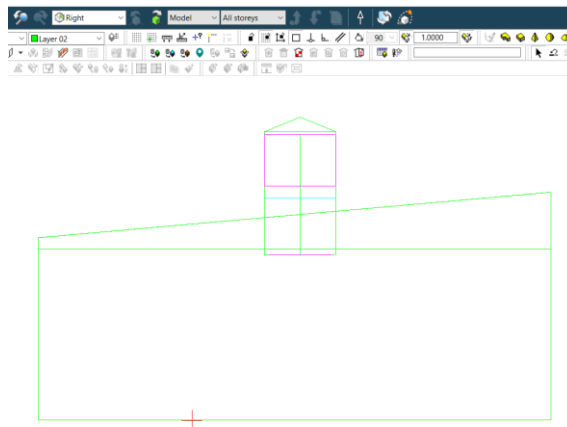
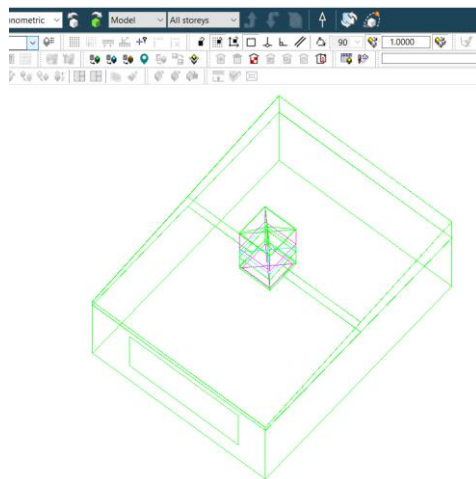

The components can also be utilised with room windows & louvres if required; however the user will need to set the Macroflo profiles up manually and ensure the set points are synchronized with the room heating/cooling profiles and Roof Terminal control profiles. Roof Terminal (without low level inlets) fixed values are:

- Plant operation 06:00 – 18:00 weekdays.
- Winter mode To < 12°C.
- Summer mode To > 18°C.
- Heating setpoint 22°C.
- Summer night cooling setpoint 16°C.
- Summer night cool operation 19:00 – 04:00 weekdays.
- CO2 setpoint 1200 – 1700 PPM.

Inserting a Passivent Roof Ventilation Terminal (with low level inlets) into a Room

For these components the same workflow as Roof Terminals (without low level inlets) is followed up to step 16; however, these products work in conjunction with room louvres and windows which need to be defined before the placement is finalised.



16. In the views check you are satisfied with the terminal position in all planes.
17. Select *Assign Aircool® louvres and windows*, a dialog will be displayed to explain the process of defining the window and louvres for automatic data assignment.

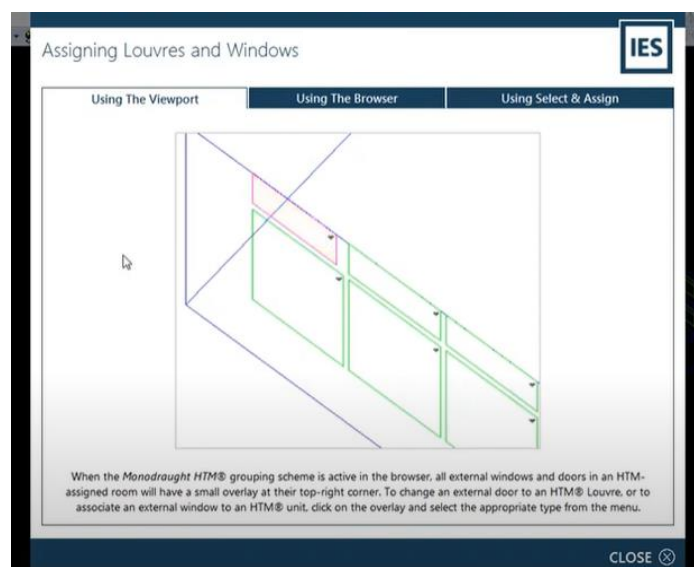

18. Pick the route you wish to utilise.
19. For the viewport route click on the triangular icon on each room opening and set the required assignment i.e. an active louvre or window under control as part of the roof terminal system.

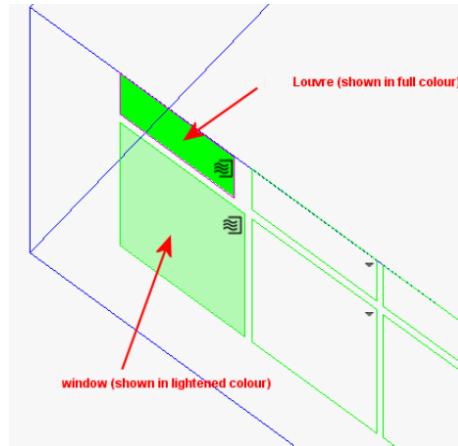

20. In the Navigator section 'Validate Roof Terminal assignments' select *Ensure that all rooms assigned Passivent Roof Terminals and louvres are valid*. This will check the assignments are valid / none are missing. A dialog will appear confirming the validation or indicating what is wrong and needs correcting before Finalize can be executed.
23. If valid now press *Finalise roof terminals*. The VE now cuts or fixes the component into the model geometry and applies data changes to the room. You will notice that target surfaces and any surfaces in spaces through which the component passes are split in two; this ensures 'island' surfaces are not created.

The act of finalising a Passivent Roof Terminal makes a number of room data modifications.

The following modifications are made to the Room Data for the room:

- The Heating Setpoint profile will be updated with the component instance setpoint value.
- The Cooling Setpoint profile will be updated with the component instance setpoint value.
- The Component operational profiles will be updated with the component instance setpoint values for heating, night cool, CO₂ and mechanical cooling (Airscoop® mixed mode only).

The following modifications are made to the associated windows and doors:

- Operational profiles for MacroFlo assignments for any associated external doors (louvres) and windows will be updated.

The following modifications are made to the ApHVAC network data for the room (Passivent Airstract® iAT and Passivent Hybrid Plus Airstract® only):

- The HVAC component operational profiles will be updated with the component instance setpoint values for heating, night cool and CO₂.

Simulation with Passivent Roof Terminals

Once you have assigned and finalised Passivent Roof Terminals to rooms in your model, the model should be ready to simulate.

You can choose to manually run pre-thermal simulations, such as SunCast (a link is provided on the Navigator) or set these to run automatically by setting them ON with the Apache simulation dialog.

Clicking the *Simulate System* action under Thermal Simulation will switch to Apache view and display the Apache Simulation dialog.

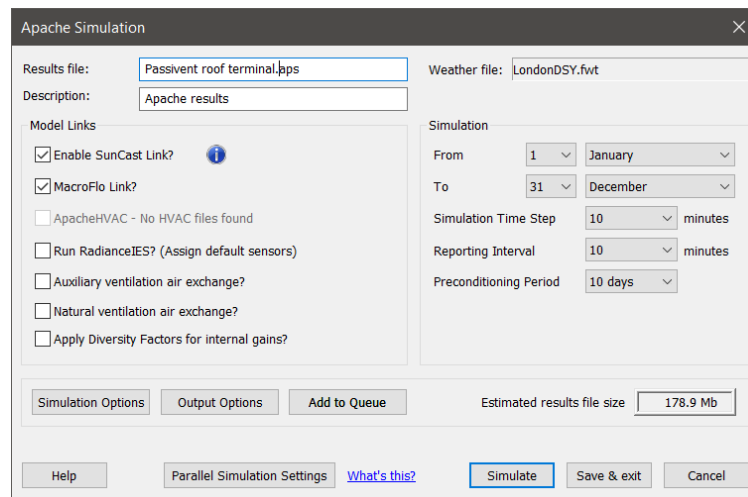

Fig 11: Apache sim sim options

In order to effectively simulate and view results for the Passivent Roof Terminals, the following simulation options are required:

- Enable SunCast Link? should be active if this has not already been generated manually.
- MacroFlo Link? should be active.
- ApacheHVAC Link? should be active for Airsttract iAT® & Hybrid Plus Airsttract® products
- Auxiliary ventilation air exchange? should be active.
- Natural ventilation air exchange? should be active.
- From / to? 1 Jan to 31 Dec.
- Simulation timestep? set to 10 mins (required for BB101:2018 CO₂ checks).
- Reporting timestep? set to 10 mins (required for BB101:2018 CO₂ checks).

If you want to see optional results detail, for example for ApHVAC component data, use output options to set this for selected rooms.

Once ready, you can start the simulation by clicking the *Simulate* button.

Once completed, the VE should switch to VistaPro for viewing and analysing the results.

4. Results analysis

Briefly to explore the performance of Roof Terminals in the VE consider the following.

- Make sure you are in VistaPro.
- Pick a results file.

Select a target room:

- Set categories weather & room ON.
- Pick Dry bulb temperature (also consider wind speed & direction).
- Pick Operative temperature (TM52/CIBSE).
- Pick Macroflo internal vent (& Macrofo external vent if windows are utilised).
- Chart the results.

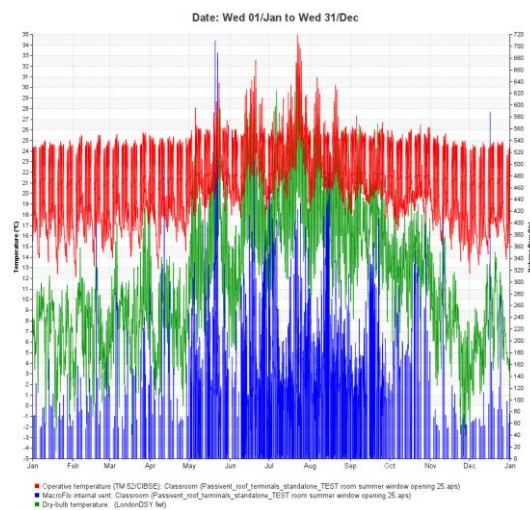

Fig 12: VistaPro – room results

- Use the calendar controls to drill down from the annual results.
- You can also pick a space or part of the Roof Terminal move down a level, pick a door (damper or louvre) and plot the equivalent area or flow rate.

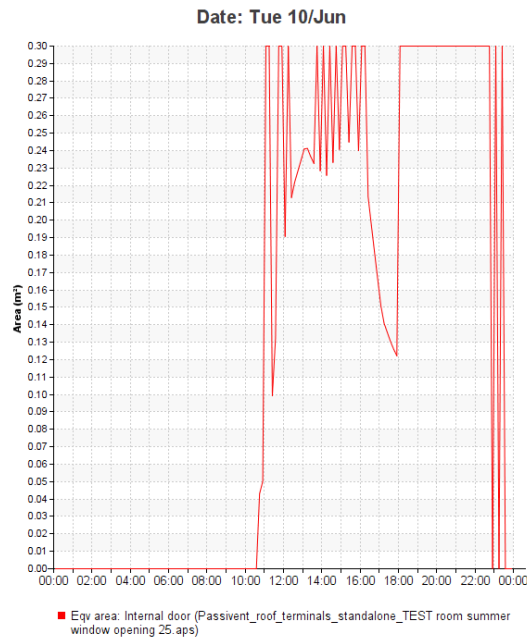

Fig 13: VistaPro – Roof Terminal damper results

Select nothing:

- Select the Macroflo arrows tool icon.
- On the viewer icon bar pick X-Ray or wire frame effect.
- Use the calendar to zoom in to a period like a day and use the drag bar to animate the timesteps.
- Use the mouse over the view to change the viewpoint, orientation and zoom to better view the visualisation.
- The screenshot below shows each opening with two directional arrows drawn at the opening plane to show the sum of inward and outward airflow over the current timestep.

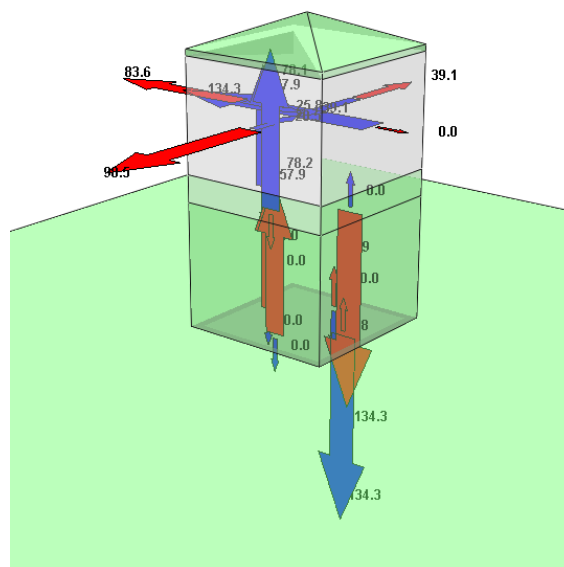

Fig 14: VistaPro – Macroflo arrows results

The next two images, for the same timestep, show Roof Terminal performance with wind from the south (from the left of the image) firstly with a Roof Terminal (with low level inlets) and secondly the same Roof Terminal but with an opening window on the room south wall.

In the first image you can see the wind driving the air down and into the room via the south windward Roof Terminal quadrant and being drawn out of the other three quadrants:

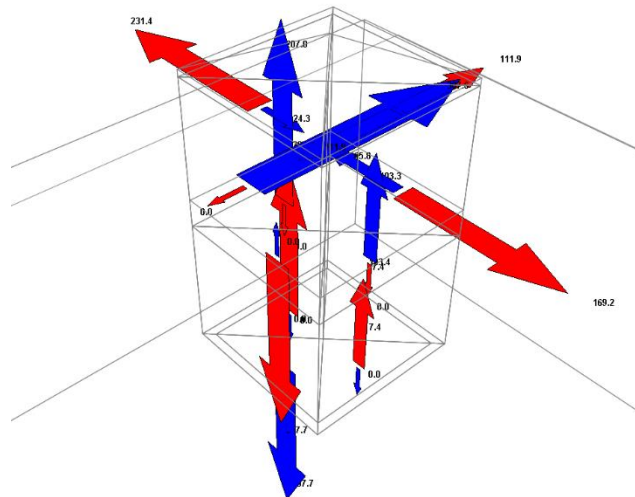

Fig 15: VistaPro – Roof Terminal (with low level inlets)

In the second image you can see the wind driven flow into the room greatly reduced in the south windward Roof Terminal quadrant as wind driven flow comes through the room so driving pressure is reduced. The airflow through the room via the window increases flow out of the east and west Roof Terminal quadrants. In this state the Roof Terminal acts mostly as an exhaust unit.

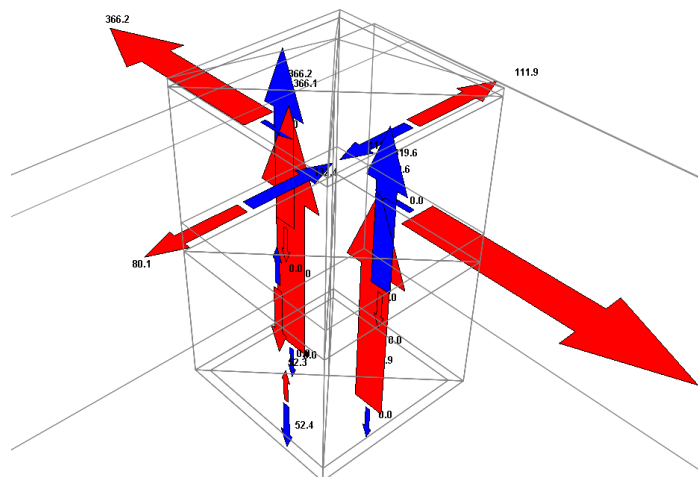

Fig 16: VistaPro – Roof Terminal with opening room window

5. Comfort analysis (design)

Depending on building type users are likely to be using TM52 or BB101 standards to assess comfort.

CIBSE TM 52 & BB101 utilise operative temperature for free-running buildings and PMV for mechanically cooled buildings. However, it is important to note that operative temperature does not fully allow for the effect of air speed on occupant comfort (see TM 52 box 1 and CIBSE Guide A).

As the Passivent Roof Terminal products are designed to provide direct airflow on occupants during the appropriate mode assessing the comfort benefit for *design purposes* (rather than compliance) might benefit from being carried out using the PMV method in all modes.

In *VistaPro* select the rooms to be included in the comfort analysis. Selecting now will include rooms.

In the *VistaPro > Comfort analysis dialog* users can select the check box for *ISO 7730: 2005*.

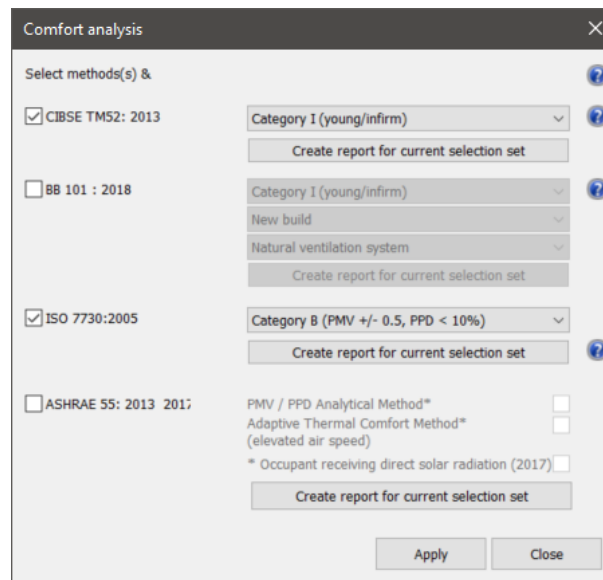

Fig 17: Vistapro – comfort analysis dialog (ISO 7730)

Select a category suitable for the project, nominally *Category B*. *Vistapro* will then post process additional room variables and these will be shown in the *VistaPro > variables picker* with the following prefixes:

1. PMV (ISO 7730 ...
2. PPD (ISO 7730 ...

A number of these variables are provided for different air speed settings so that the benefit of the Passivent Roof Terminals® unit can be assessed and compared. Variables prefixed *ISO 7730 nom & elev air speed ...* apply the elevated air speed per time-step when the PMV calculated at the nominal air speed exceeds the selected category upper limit (for category B this is PMV +0.5) thus reflecting the function of the Passivent Roof Terminals® unit.

Clothing also affects comfort; this is set for each room by template or on space data:

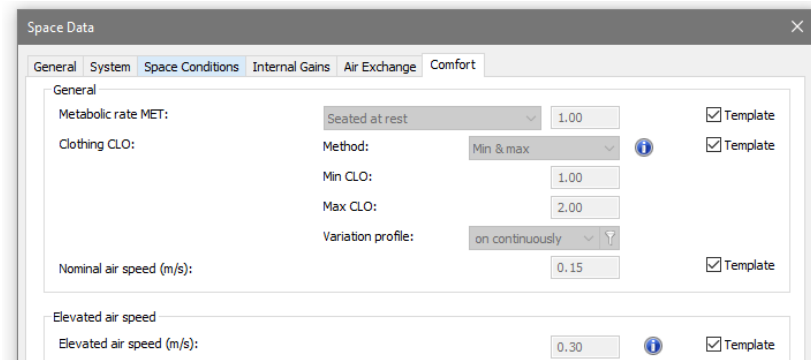

Fig 18: Space data comfort tab

As comfort is post-processed these inputs can be changed post-simulation. CLO value can be fixed, set by profile or set to a min or max value per time-step to give a best result (See VE help); these options provide a means to mimic occupant behaviour. Sensible default values are applied when Passivent Roof Terminals is assigned or re-assigned to a space.

On this dialog you can also adjust the nominal and elevated air speed values for this assessment.

Typically, one might compare *PMV (ISO 7730 nominal air speed)* with say *PMV (ISO 7730 nom & elev air speed cat B)* to assess the benefit of the Passivent Roof Terminals summer operation for design purposes.

The *Create report ...* option on the dialog will generate a report.

6. Comfort analysis (compliance)

Depending on building type users are likely to be using TM52 or BB101 standards to meet UK & Eire compliance requirements. Both standards can be accessed via the *VistaPro > Comfort analysis dialog*.

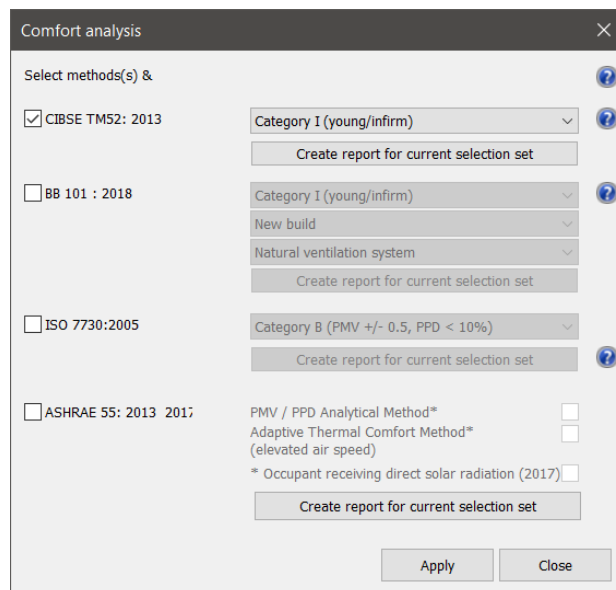

Fig 19: Vistapro – comfort analysis dialog (BB101)

Taking BB101:2018 as the example; set the user category, the build type, and the system type. For Passivent Roof Terminals the system type should be set as follows:

- Airscoop® – natural ventilation system
- Airscoop® with mixed mode cooling – hybrid ventilation system
- Airstract® – natural ventilation system
- Airstract iAT® – natural ventilation system¹
- Hybrid Plus Airstract - natural ventilation system²
- Litevent – natural ventilation system

1 Airstract iAT® is free running for the majority of the time and the fan within it is not there to deal with CO2 but only there to deal with overheating and to boost ventilation if required on a hot day as it is also supplemented with low level openings be that a window or an Aircool® device. In winter-time when CO2 levels are being targeted (rather than internal temperatures) the boost fan wouldn't be expected to come on so 'mechanical mode' is not applicable.

2 Hybrid Airstract® has been argued to be a natural ventilation system as during winter-time if you switch the fan off you will still get a natural exchange of air from the room to the outside. The purpose of the fan in this unit is just to prevent a cold draught from occurring so wouldn't be considered as a mechanical ventilation system as it's predominately used for occupant comfort against cold draughts rather than being required to deal with CO2.

Now press the *Create report* option. The VE will carry out the analysis with these settings and export a report in Excel format.

For Airscoop with mixed mode cooling the analysis will assess periods when cooling is operating separately to free running periods.

For Roof terminals with fans the analysis will assess periods when fans are operating separately to free running & mechanical cooling periods.

Overall														
Passed:		5 rooms:												
Failed:		0 rooms:												
Unoccupied:		0 rooms:												
Data:														
Building category:		Category II New build												
Weather file:		London_DSY.fwt												
Days data:		365	01-Jan	31-Dec										
Days (Summer):		153	01-May	30-Sep										
Data OK?		OK Full summer												
Occupancy:														
Note:		This report assesses occupied periods only. Please be aware that TMS2 / BB101:2018 should be conducted for occupied and/or "available hours".												
Note:		BB101:2018 requires occupied periods during August so NCM profiles are not appropriate.												
Note:		See Section 6.1.2 (a) of TMS2 for further information.												
Note:		See section 2.4 of BB10:2018 for further information.												
Passed:														
5 rooms:		Adaptive comfort checks					PMV comfort checks (mechanically cooled)			CO2 performance checks (natural mode)				
Room Name	Room ID	Occupied hours in natural mode	Criteria 1 (N/Hrs Top-Tmax>=1K)	Criteria 2 (Max. Daily Deg.Hrs)	Criteria 3 (Max. DeltaT)	Criteria failing	Occupied hours in cooled mode	Hours PMV > +0.5	Criteria met	Occupied hours in natural mode	Max daily average (< 1500 PPM)	Max 20 min peak (< 2000 PPM)	All occupied hours average (1200 PPM)	Criteria met
1														
2	L00: Room (P 1)	L0000000	1000	0	0	0 -	820	0	y	1000	1350	1950	1050	y
3	L00: Room (P 2)	L0000001	1000	0	0	0 -	820	0	y	1000	1350	1950	1050	y
4	L00: Room (P 3)	L0000002	1000	0	0	0 -	820	0	y	1000	1350	1950	1050	y
5	L00: Room (P 4)	L0000003	1000	0	0	0 -	820	0	n	1000	1350	1950	1050	y
6	L00: Room (C)	L0000004	1000	0	0	0 -	820	0	y	1000	1350	1950	1050	y
Failed:														
0 rooms:														
Room Name	Room ID	Occupied hours in natural mode	Criteria 1 (N/Hrs Top-Tmax>=1K)	Criteria 2 (Max. Daily Deg.Hrs)	Criteria 3 (Max. DeltaT)	Criteria failing	Occupied hours in cooled mode	Hours PMV > +0.5	Criteria met	Occupied hours in natural mode	Max daily average (< 1500 PPM)	Max 20 min peak (< 2000 PPM)	All occupied hours average (1200 PPM)	Criteria met
Unoccupied:														
0 rooms:														
Room Name	Room ID	Occupied hours in natural mode	Criteria 1 (N/Hrs Top-Tmax>=1K)	Criteria 2 (Max. Daily Deg.Hrs)	Criteria 3 (Max. DeltaT)	Criteria failing	Occupied hours in cooled mode	Hours PMV > +0.5	Criteria met	Occupied hours in natural mode	Max daily average (< 1500 PPM)	Max 20 min peak (< 2000 PPM)	All occupied hours average (1200 PPM)	Criteria met
Note:														
ATM 52 2013 analysis provides an assessment of comfort compliance based on bulk air modelling														
i.e. each space is considered idealised and the air in the space perfectly mixed. The assessment does														
not assess placement of space features e.g. windows & openings, airflow patterns or discomfort issues.														
The user should assess these design aspects outside of the TMS2 analysis.														

< update – example BB101 report >

Overall:		5 rooms:																		
Passed:		0 rooms:																		
Failed:		0 rooms:																		
Unoccupied:		0 rooms:																		
Data:																				
Building category: Category II																				
New build																				
Weather file: London_DSI_Fut																				
Days date: 365																				
Days (summer): 253																				
Date OK? Full summer																				
Occupancy:																				
Note: This report assesses occupied periods only. Please be aware that TMS2 / BB101:2018 should be conducted for occupied and/or "available hours".																				
BB101:2018 requires occupied periods during August so NCM profiles are not appropriate.																				
See Section 6.1.2 (a) of TMS2 for further information.																				
See section 2.4 of BB101:2018 for further information.																				
Passed:		Adaptive comfort checks					PMV comfort checks (mechanically cooled)		CO2 performance checks (natural mode)				CO2 performance checks (mechanical mode)							
Room Name	Room ID	Occupied hours in natural mode	Criteria 1 (Nhrs Top-Tmax+1K)	Criteria 2 (Max Daily Deg.Hrs)	Criteria 3 (Max DeltaT)	Criteria failing	Occupied hours in cooled mode	Hours PMV > +0.5	Criteria met	Occupied hours in natural mode	Max daily average (< 1500 PPM)	Max 20 min peak (< 2000 PPM)	All occupied hours average (< 1200 PPM)	Criteria met	Occupied hours in mech/hybrid mode	Max daily average (< 1000 PPM)	Max 20 min peak (< 1500 PPM)	Criteria met		
L00_Room (P 1)	L0000000	1000	0	0	0	-	820	0	y	1000	1350	1950	1950	y	820	1350	1950	y		
L00_Room (P 2)	L0000001	1000	0	0	0	-	820	0	y	1000	1350	1950	1950	y	820	1350	1950	y		
L00_Room (P 3)	L0000002	1000	0	0	0	-	820	0	y	1000	1350	1950	1950	y	820	1350	1950	y		
L00_Room (P 4)	L0000003	1000	0	0	0	-	820	0	n	1000	1350	1950	1950	y	820	1350	1950	y		
L00_Room (C)	L0000004	1000	0	0	0	-	820	0	y	1000	1350	1950	1950	y	820	1350	1950	y		
Failed:																				
Room Name	Room ID	Occupied hours in natural mode	Criteria 1 (Nhrs Top-Tmax+1K)	Criteria 2 (Max Daily Deg.Hrs)	Criteria 3 (Max DeltaT)	Criteria failing	Occupied hours in cooled mode	Hours PMV > +0.5	Criteria met	Occupied hours in natural mode	Max daily average (< 1500 PPM)	Max 20 min peak (< 2000 PPM)	All occupied hours average (< 1200 PPM)	Criteria met	Occupied hours in mech/hybrid mode	Max daily average (< 1000 PPM)	Max 20 min peak (< 1500 PPM)	Criteria met		
Unoccupied:																				
Room Name	Room ID	Occupied hours in natural mode	Criteria 1 (Nhrs Top-Tmax+1K)	Criteria 2 (Max Daily Deg.Hrs)	Criteria 3 (Max DeltaT)	Criteria failing	Occupied hours in cooled mode	Hours PMV > +0.5	Criteria met	Occupied hours in natural mode	Max daily average (< 1500 PPM)	Max 20 min peak (< 2000 PPM)	All occupied hours average (< 1200 PPM)	Criteria met	Occupied hours in mech/hybrid mode	Max daily average (< 1000 PPM)	Max 20 min peak (< 1500 PPM)	Criteria met		
Note: A TM 52 2013 analysis provides an assessment of comfort compliance based on bulk air modelling i.e. each space is considered idealised and the air in the space perfectly mixed. The assessment does not assess placement of space features e.g. windows & openings, airflow patterns or discomfort issues. The user should assess these design aspects outside of the TMS2 analysis.																				

< update – example BB101 report >

7. UK NCM analysis (Part L & EPCs)

The NCM framework

The National Calculation Methodology (NCM) is the framework defined by the UK Government for the analysis of buildings and their systems for the purpose of analysis relating to Part L (for England, Wales and Northern Ireland), Section 6 (for Scotland), and Energy Performance Certificates (for all UK regions).

NCM analyses are governed by rules setting out the simulation methods to be used and the conditions applying in those simulations. Set-points, occupancy, DHW consumption, internal gains and minimum ventilation rates are specified for a standardised set of building types and activities. Systems are organised into categories, infiltration rates are calculated by approved methods, and rules are laid down for the calculation of energy used by fans and pumps ('auxiliary energy'). These rules mean that conditions and methods used within the NCM framework to simulate the *Actual Building* (a specialised NCM term) may differ from those applicable to the *real building* (the building as designed, occupied and operated).

Analysing the Real Building and the Actual Building

The preceding sections of this user guide describe the approach to analysing the real building, using simulation methods tailored to the detailed representation of systems.

In order to comply with the special requirements of NCM a modified approach is required for NCM modelling of Roof Terminals. This involves analysis of the *Actual Building* and the buildings which the software derives automatically from it – the *Notional Building* and (for EPC purposes) the *Reference Building*. These analyses are performed in the *VE Compliance* view of the VE, where tools are provided to facilitate the input and editing of the additional data items.

Because some of the data required for NCM is shared with the analysis of the real building, NCM analysis is conducted on a copy of the real building model modified to accommodate the NCM requirements.

In the VE UK Compliance view a model with Passivent Roof Terminals should have the Apache simulation options set to Macroflo ON (it is normally OFF).

For heated-only rooms served by Passivent Roof Terminal systems, *Cooling/vent.* on the *Cooling* tab should be set to Natural or Mechanical ventilation (Airstract iAT® and Hybrid Plus Airstract®).

For Airscoop® mixed mode (mechanical cooling) an Apache System should be created with an appropriate air conditioning system type. The characteristics of this system should be entered via the *UK NCM system data wizard*, starting with the selection of a suitable system type from the *UK NCM system type* menu e.g. *Passive chilled beam* or *Split system* and in this case *Changeover mixed mode free cooling* on the Apache System *Cooling* tab should be set to *Natural ventilation*.

For Roof Terminals where fans are also operational i.e. Airstract iAT® and Hybrid Plus Airstract® the ApHVAC networks cannot be utilised for NCM compliance, however the electricity consumption of the ventilation fans, must, however, be accounted for.

Close attention should be paid to the settings on the *System adjustment*, *Metering Provision* and *System controls* tabs of the UK NCM system data wizard, since these have a critical effect on performance as assessed by the Regulations.

When the Apache Systems have been created, they must be assigned as appropriate to each room served by a Passivent Roof Terminals system. These assignments can be made (to the **System** field on the System tab) either in the Building Template Manager or in the room's Space Data dialog.

On the *System* tab of the Room Data dialog for each room served by a Passivent Roof Terminals system:

- *System* and *Auxiliary vent. system* should be set to the appropriate Apache System.
- *DHW system* should be set to the Apache System created for this purpose.
- *Demand controlled ventilation Type* should be set to *Demand control based on occupancy density (Cd = 0.85)*.

Where the Passivent Roof Terminals system provides all the ventilation, the *Air supply* setting on the *Ventilation* tab of the *UK NCM system data wizard* should be set to *Local ventilation-only units, such as window/wall/roof units serving a single area*. The mechanical ventilation component of the system will be taken into account via SFP adjustments described below. It should be noted that the aspects of the system which provide benefit in the form of reduced summertime temperatures do not explicitly receive credit for this benefit under the current NCM *Criterion 3* rules, which in contrast to earlier editions of the Regulations are expressed exclusively in terms of reduced solar gain. However, this aspect of performance will form an important part of the design as assessed by the performance of the *real building*.

Set up this way, the system will be assessed for regulatory purposes against a comparable system in the *Notional Building*.

Fan power used by a Passivent Roof Terminals system is represented within the NCM framework as a component of *auxiliary energy*. This is the sum of contributions from pumps and fans. Pump power is a function of system category and subject to limited user control. Fans fall into two categories – central and local – for each of which a specific fan power (SFP) must be specified.

In the case of heating-only systems for which ventilation is provided locally the SFP parameter on the Apache System dialog (System specific fan power (SFP)) should be set to zero and a suitable SFP value entered on the *System* tab of the Room Data dialog for each room (ventilation & extract > local mechanical exhaust in room?). This value should represent the average SFP applicable to the room ventilation during operating hours, accounting for the fact that for many hours the fan will be off. A suitable value (which will typically be very small) should be derived from detailed simulations performed (under equivalent assumptions) for the real building. For Airscoop (standalone) this value will be zero.

A separate Apache System, with suitable operation parameters, should be created to provide domestic hot water (DHW), and assigned to the rooms for this purpose.

For the model used for NCM analysis, infiltration is set using parameters on the *Building & System Data* dialog.

On the **Simulations Settings** tab of the **Building & System Data** dialog (accessed via the button **Set Building & System Data** at the bottom of the screen):

SunCast link? should be ticked if a suitable shading file has been generated.

MacroFlo link? should be *ticked*.

HVAC link? should be *unticked* (in contrast to the setting in Apache View).

Radiance link? should be *unticked*.

Natural ventilation air exchange? should be *unticked*.

With regard to the numerous other data inputs relating to NCM presented in the VE Compliance view, reference should be made to the general guidance provided on this aspect of the software.